

Rev	Revisions	Rev.Drawn	Date
A			16,04,08

HOUSING WW210-M01

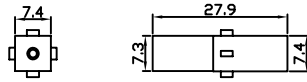

HOUSING WW210-M04

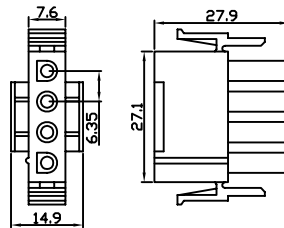

HOUSING WW210-M06

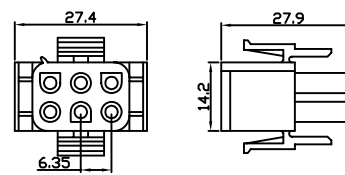

HOUSING WW210-M15

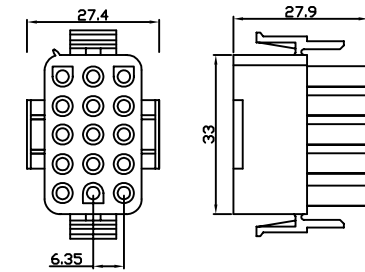

HOUSING WW210-M02

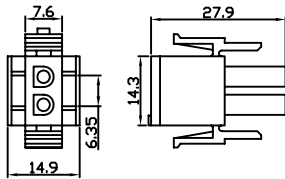

HOUSING WW210-M09

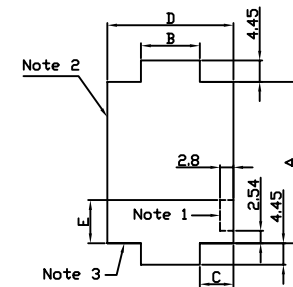
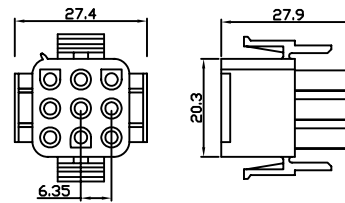

HOUSING WW210-M03

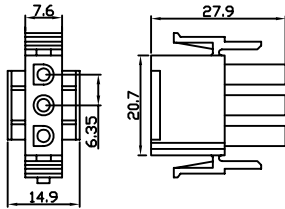

HOUSING WW210-M05

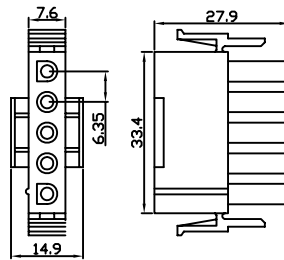

HOUSING WW210-M12

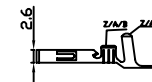
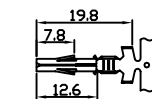
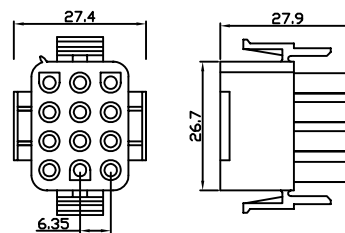

Number of Circuits	Dimensions				
	A	B	C	D	E
2	14.35	8.65	2.40	13.50	6.35
3	20.70	8.65	2.40	13.50	6.35
4	27.05	8.65	2.40	13.50	6.35
5	33.40	8.65	2.40	13.50	6.35
6	14.35	12.20	7.00	26.15	6.35
9	20.70	12.20	7.00	26.15	6.35
12	27.05	12.20	7.00	26.15	8.90
15	33.40	12.20	7.00	26.15	8.90

Terminal remover

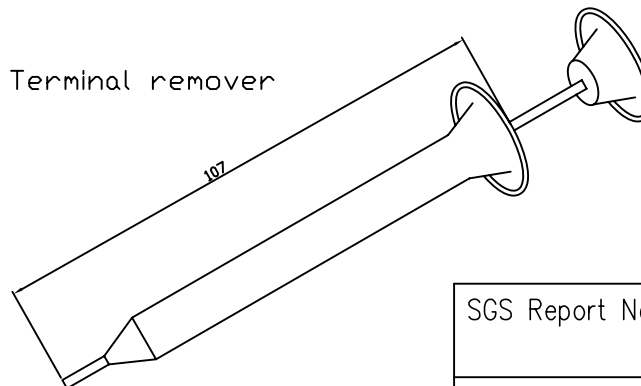

**SST** SOUTH SEA TERMINAL CO.,LTD

SGS Report No.:	Customer:	Part No.: WW210-MXX
Title: /		
Drawn By: Storm.Li	SCALE 1:1	SHEET 1/1
Checked By: Simmon	REV. A	DWG NO.:
Approved By: Tony	TOLERANCE:	
Thire angle Projection		Units mm
General Dimension Tolerance		
ANGLES ±		